

JVC



ENGLISH

ESPAÑOL

FRANÇAIS

MOBILE COLOR MONITOR SYSTEM SISTEMA DE MONITOR EN COLOR MÓVIL SYSTÈME DE MONITEUR MOBILE EN COULEUR

KV-M65

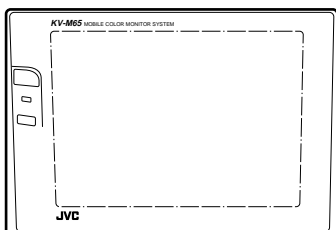

Display unit
Unidad de visualización
Unité d'affichage

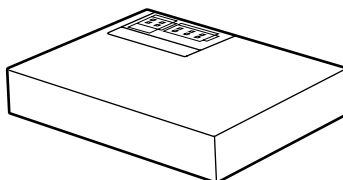

Controller unit
Unidad controladora
Unité de commande

For installation and connections, refer to the separate manual.

Para realizar la instalación y las conexiones, consulte el manual separado.

Pour l'installation et les raccordements, se référer au manuel séparé.

* This system cannot receive television broadcasts and is primarily designed for use with a VCR. Use the separately sold mobile TV tuner system KV-C1 for optional television broadcast reception.

* Este sistema no puede recibir emisiones de televisión, y ha sido diseñado principalmente para ser utilizado con una videograbadora. Utilice el sistema de sintonizador de TV móvil KV-C1 vendido por separado para recibir emisiones de televisión opcionales.

* Ce système ne peut recevoir les émissions de télévision, et il est essentiellement conçu pour l'utilisation avec un magnétoscope. Utilisez le tuner avec système de tuner TV mobile KV-C1 vendu séparément pour la réception optionnelle des émissions de télévision.

INSTRUCTIONS **MANUAL DE INSTRUCCIONES** **MANUEL D'INSTRUCTIONS**

For customer Use:

Enter below the serial No. which is located on the rear of cabinet. Retain this information for future reference.

Model No. **KV-M65**

Serial No. _____

Safety points (Be sure to follow these points)

CAUTIONS

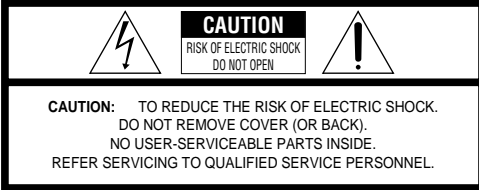

The lightning flash with arrowhead symbol, within an equilateral triangle, is intended to alert the user to the presence of uninsulated "dangerous voltage" within the product's enclosure that may be of sufficient magnitude to constitute a risk of electric shock to persons.



The exclamation point within an equilateral triangle is intended to alert the user to the presence of important operating and maintenance (servicing) instructions in the literature accompanying the appliance.

WARNING:

TO PREVENT FIRE OR SHOCK HAZARD, DO NOT EXPOSE THIS UNIT TO RAIN OR MOISTURE.

CAUTION:

This monitor system should be used with DC 12V only. To prevent electric shocks and fire hazards, DO NOT use any other power source.

This Class B digital apparatus meets all requirements of the Canadian Interference-Causing Equipment Regulations.

"Cet appareil numérique de la classe B respecte toutes les exigences du Règlement sur le matériel brouilleur du Canada."

Warnings

- DO NOT INSTALL THE MONITOR IN A LOCATION WHICH OBSTRUCTS DRIVING, VISIBILITY OR WHICH IS PROHIBITED BY APPLICABLE LAWS AND REGULATIONS.
- THERE MAY BE LEGAL REGULATIONS DEFINING THE PERMISSIBLE INSTALLATION LOCATIONS FOR THE DISPLAY UNIT WHICH DIFFER BY COUNTRY OR BY STATE, BE SURE TO INSTALL THE DISPLAY UNIT IN A CORRECT LOCATION ACCORDING TO SUCH LAWS.
- DO NOT INSTALL THE MONITOR SYSTEM IN A LOCATION WHICH OBSTRUCTS THE OPERATION OF AN AIR BAG.
- THE DRIVER MUST NOT OPERATE THE COLOR MONITOR SYSTEM WHILE DRIVING. OPERATING THE COLOR MONITOR SYSTEM WHILE DRIVING MAY LEAD TO CARELESSNESS AND CAUSE AN ACCIDENT.
 - * STOP YOUR VEHICLE IN A SAFE LOCATION WHEN OPERATING THE TV TUNER SYSTEM.
- THE DRIVER MUST NOT WATCH THE TELEVISION OR VIDEOS WHILE DRIVING. IF THE DRIVER WATCHES THE TELEVISION OR A VIDEO WHILE DRIVING, IT MAY LEAD TO CARELESSNESS AND CAUSE AN ACCIDENT.

CAUTION :

Change or modifications not approved by JVC could void user's authority to operate the equipment. This equipment has been tested and found to comply with the limits for a Class B digital device, pursuant to Part 15 of the FCC Rules. These limits are designed to provide reasonable protection against harmful interference in a residential installation. This equipment generates, uses, and can radiate radio frequency energy and, if not installed and used in accordance with the instructions, may cause harmful interference to radio communications.

However, there is no guarantee that interference will not occur in a particular installation. If this equipment does cause harmful interference to radio or television reception, which can be determined by turning the equipment off and on, the user is encouraged to try to correct the interference by one or more of the following measures:

Reorient or relocate the receiving antenna.

Increase the separation between the equipment and receiver.

Connect the equipment into an outlet on a circuit different from that to which the receiver is connected.

Consult the dealer or an experienced radio/TV technician for help.

- **WHEN LIGHTNING OCCURS, DO NOT TOUCH THE ANTENNA WIRE OR THE TELEVISION. TOUCHING THE ANTENNA WIRE OR THE TELEVISION UNDER SUCH CONDITIONS MAY CAUSE ELECTROCUTION.**
- **KEEP THE MONITOR SYSTEM AT AN APPROPRIATE SOUND LEVEL WHILE DRIVING. DRIVING WITH THE SOUND AT A LEVEL THAT PREVENTS YOU FROM HEARING SOUNDS OUTSIDE OF AND AROUND THE VEHICLE MAY CAUSE AN ACCIDENT.**
- **ASK A TRAINED TECHNICIAN TO INSTALL THE MONITOR SYSTEM. INSTALLATION AND WIRING REQUIRE TRAINING AND EXPERIENCE.**
* **TO BE SAFE, ASK THE SALES OUTLET WHERE YOU PURCHASED THE MONITOR SYSTEM TO PERFORM THE INSTALLATION.**
- **DO NOT LET THE MONITOR SYSTEM FALL OR BE STRONGLY IMPACTED. BE SURE TO NOT LET THE MONITOR SYSTEM FALL OR BE STRONGLY IMPACTED SINCE THIS MAY CAUSE A MALFUNCTION OR FIRE.**
- **DO NOT WATCH THE MONITOR WITH THE ENGINE OFF. WATCHING THE MONITOR WITH THE ENGINE OFF WILL CONSUME BATTERY POWER AND MAY PREVENT THE ENGINE FROM STARTING.**

Cautions for the liquid crystal panel

- Do not leave the liquid crystal panel surface facing upwards on top of the dashboard. (storage temperature range: -20°C to $+80^{\circ}\text{C}$ (-4°F to $+176^{\circ}\text{F}$))

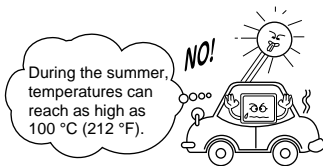
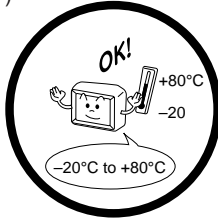

When the liquid crystal panel reaches high temperatures or low temperatures, chemical changes occur within the liquid crystal panel which may cause malfunctions.

- Do not strongly impact the liquid crystal panel.

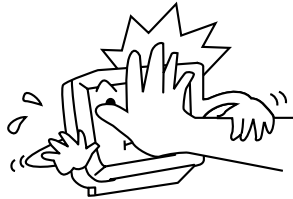

- There are red spots, blue spots and green spots on the panel surface. This is a characteristic of liquid crystal panels and is not a problem.

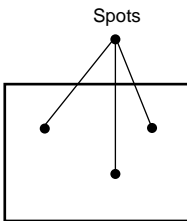

The liquid crystal panel is built with very high precision technology and has at least 99.99% effective image pixels. Be aware that on 0.01% of the panel there may be missing pixels or constantly light pixels.

- When the temperature is very cold or very hot, the image may not appear clearly or may move slowly.

Also, movement of the image may seem to be out of sync or the image quality may decline in such environments. Note that this is not a malfunction or problem.

(usage temperature range: 0°C to $+40^{\circ}\text{C}$ (32°F to 104°F))

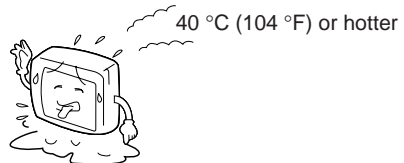
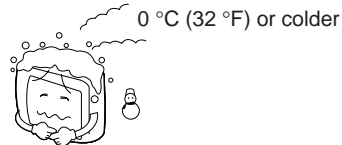

Thank you for purchasing a JVC product. Please read all instructions carefully before operation, to ensure your complete understanding and to obtain the best possible performance from the unit.

Table of Contents

Introduction to the Roles of the System Components	6
How to Use the Monitor System	
Controlling the Sound	9
Adjusting Brightness	12
Adjusting the Sound	16
Adjusting the Image	18
Connecting to External Devices	20
How to Best Use the Monitor System	
Troubleshooting	21
Maintenance	22
Specifications	23

Introduction to the Roles of the System Components

Controller unit

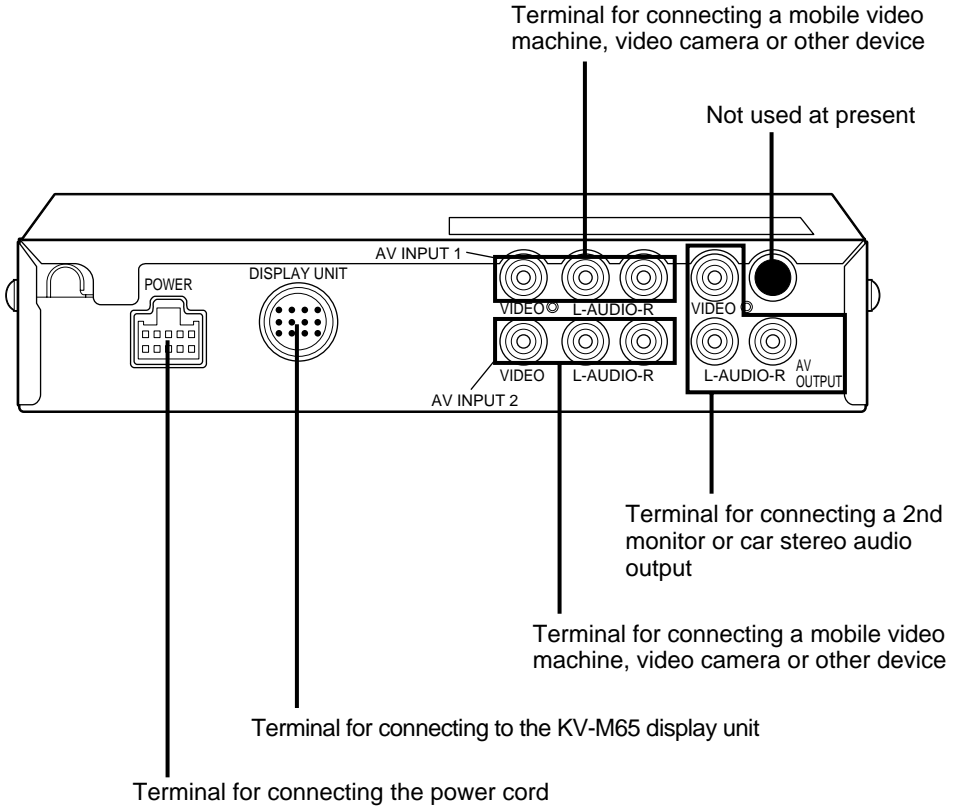

Introduction to the Roles of the System Components (continued)

KV-M65 display unit

The numbers in the circles (○) indicate the page on which an explanation is provided in this manual.

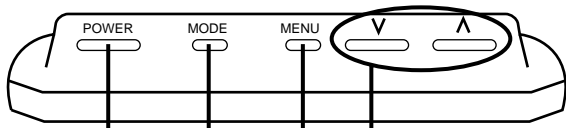

Used to turn the power source ON and OFF

- Normally:
Changing the channel setting in the upward or downward direction (only when connected to the KV-C1)
- When setting various menus:
Menu selection
- When setting various adjustment modes:
Adjustment and switching

Used to display, select and determine the various adjustments (screen, menu).

Used to display the configuration screen for changing the input source and the various function menus.

When set to the TV mode, channel numbers are shown. Note, however, that television broadcast reception requires connection to the separately sold KV-C1 mobile TV tuner system.

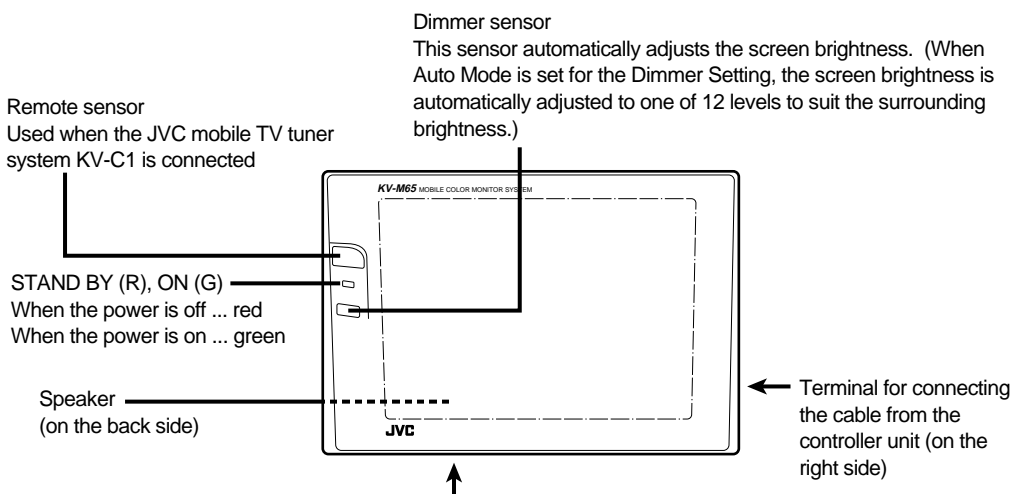

Remote sensor
Used when the JVC mobile TV tuner system KV-C1 is connected

Dimmer sensor
This sensor automatically adjusts the screen brightness. (When Auto Mode is set for the Dimmer Setting, the screen brightness is automatically adjusted to one of 12 levels to suit the surrounding brightness.)

STAND BY (R), ON (G)
When the power is off ... red
When the power is on ... green

Speaker
(on the back side)

Terminal for connecting the cable from the controller unit (on the right side)

Screw holes are provided for attaching the monitor stand (on the bottom side).
(1/4 inch unify screw, maximum length of 4.5 mm)

MODE button

When pressed for less than 2 seconds: The input source can be changed.

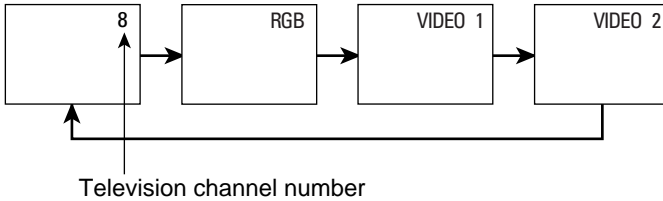

When pressed for 2 seconds or longer: The setting screens for various functions can be displayed.

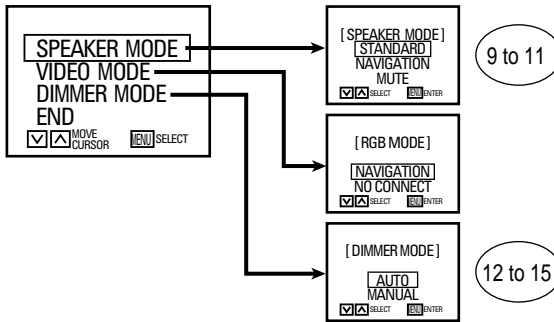

MENU button

When pressed for less than 2 seconds: The adjustment screen display can be selected. (The following diagram shows an example for the Speaker Output Setting on All Modes and the Dimmer Setting on Auto Mode.)



When pressed for 2 seconds or longer: The menus for image and sound can be displayed.



When setting the menus: The Menu selection and adjustment can be decided.

Controlling the Sound

Selecting the volume of the built-in speakers

(The monitor system is set to STANDARD at the time of shipment from the factory.)

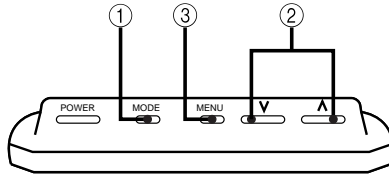

- ① Press the MODE button for 2 seconds or longer.

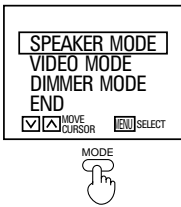

- ② Select the SPEAKER MODE.

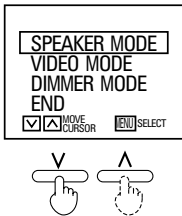

- ③ Press the MENU button.

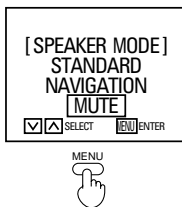

Note

- If no operations are performed for a period of 30 seconds after pressing the MODE button: The Menu configuration screen automatically disappears.

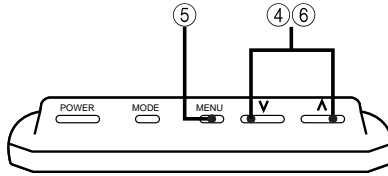

④ Select STANDARD.

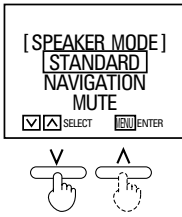

⑤ After the SPEAKER MODE screen disappears (occurs after about 10 seconds), press the MENU button for less than 2 seconds and show the speaker volume level display.

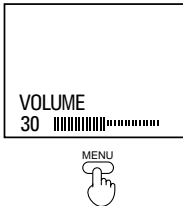

⑥ Adjust the speaker volume level.

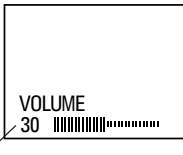

Sound level (0-60 levels)

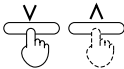

Note

- Relationship between the Speaker mode setting and the built-in speaker volume

Speaker mode setting	Built-in speaker volume			
	Television	RGB	Video 1	Video 2
STANDARD	Television sound	–	Video 1 sound	Video 2 sound
NAVIGATION	Not used at present. Please select either STANDARD or MUTE.			
MUTE	There is no sound output from the speakers			

- Speaker output is monaural sound. (It is not heard as stereo sound.)

Adjusting the volume output level of the AV output terminal

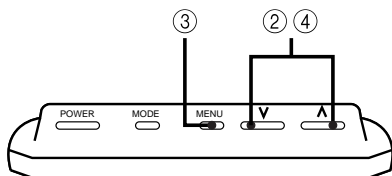

- ① Perform steps 1 to 3 on page 9.
 - Ⓐ Press the MODE button for 2 seconds or longer.
 - Ⓑ Select the SPEAKER MODE setting using the [V] and [^] buttons.
 - Ⓒ Press the MENU button.
- ② Select MUTE.

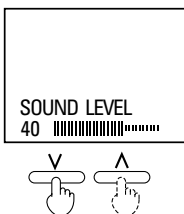
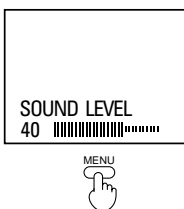
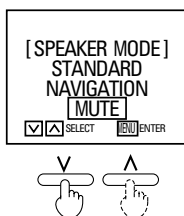

- ③ After the SPEAKER MODE setting screen disappears (occurs after about 10 seconds), press the MENU button for less than 2 seconds and show the volume level display.
- ④ Adjust the volume output level of the AV output terminal.

Note

- When the SPEAKER MODE setting is on STANDARD:

The output level is fixed to the maximum of 60 and cannot be adjusted. (See page 10 for more details.)

Adjusting Brightness

For the automatic mode

(The monitor system is set to the Auto Mode at the time of shipment from the factory.)

Automatically adjusts the screen brightness to suit the brightness of the surrounding environment.

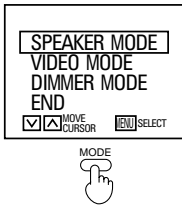
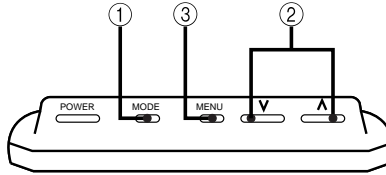

- ① Press the MODE button for 2 seconds or longer.

Note

- When END is selected, the system returns to the initial screen.

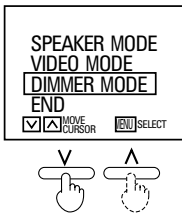

- ② Select the DIMMER MODE.

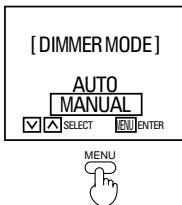

- ③ Press the MENU button.

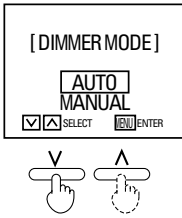
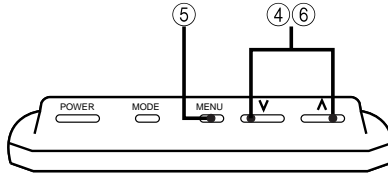

- ④ Select AUTO.

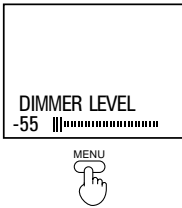

- ⑤ After the DIMMER MODE disappears (occurs after about 10 seconds), press the MENU button for less than 2 seconds and show the automatic dimmer (darkness level) display.

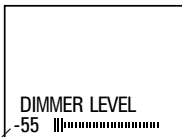

- ⑥ Use the [V] or [^] button to adjust brightness to the best visibility at night.

When set to 0, the brightness does not change.



Note

- When the adjustment is made to the best visibility at night, the system automatically adjusts the level between the maximum brightness and the brightness for the best visibility at night (minimum brightness). (It is recommended that the setting be put between -40 and -60).
- When 0 is set, the value is fixed to the maximum level and the brightness does not change.

Adjusting Brightness

For the manual mode

The screen brightness can be adjusted manually.

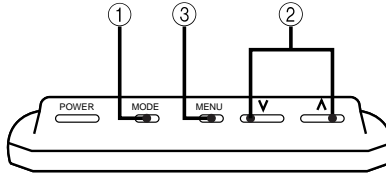

- ① Press the MODE button for 2 seconds or longer.

Note

- When END is selected, the system returns to the initial screen.

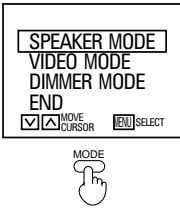

- ② Select the DIMMER MODE.

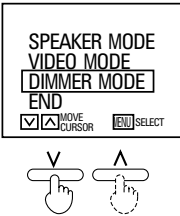

- ③ Press the MENU button.

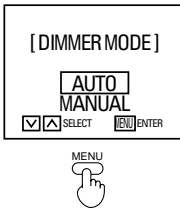

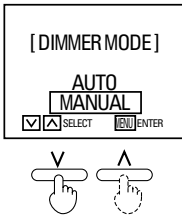
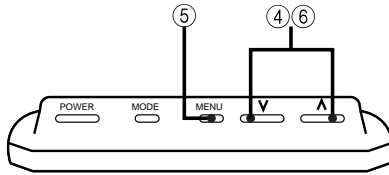

- ④ Select MANUAL.

Note

- When MANUAL is selected in advance:

With the wireless remote controller, it is possible to set this level directly using the Brightness button.

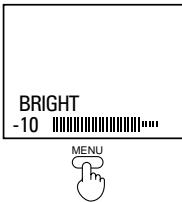

- ⑤ After the DIMMER MODE disappears (occurs after about 10 seconds), press the MENU button for less than 2 seconds and show the brightness display.

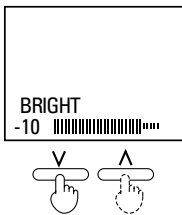

- ⑥ Use the [V] or [^] button to adjust the brightness to your preferred level.

Adjusting the Sound

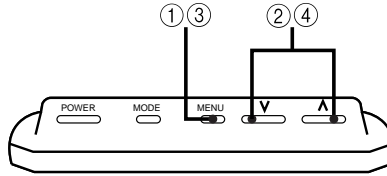

Example: Adjusting the bass level

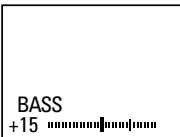
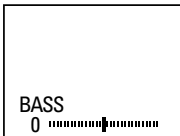
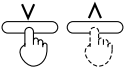

① Press the MENU button for 2 seconds or longer.

② Select BASS.

③ Press the MENU button.

④ Adjust the BASS level.

Note

- After 10 seconds passes:

The BASS Adjustment screen automatically disappears.

Note

- When END is selected, the system returns to the initial screen.
- Bass, Treble, Balance and Surround do not change in the case of a built-in speaker.

Adjustment points (The bass, treble and balance can be adjusted from the setting screens)

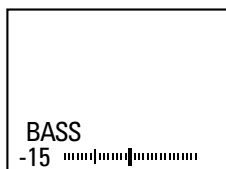

Bass is reduced.

BASS

(level of low tones)

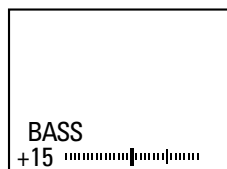

Bass is increased.

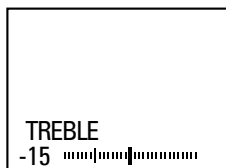

Treble is reduced.

TREBLE

(level of high tones)

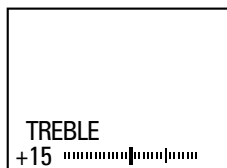

Treble is increased.

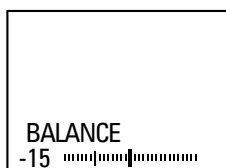

Sound output of the right side is lowered.

BALANCE

Balances the sound output between the left and right speakers

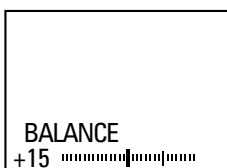

Sound output of the left side is lowered.

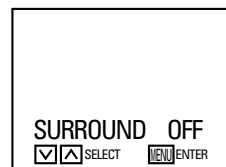

SURROUND

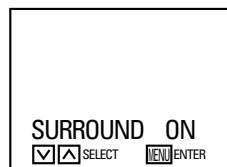

The feature gives a 3D effect to the sound when VIDEO1 or VIDEO2 is in stereo format.

Adjusting the Image

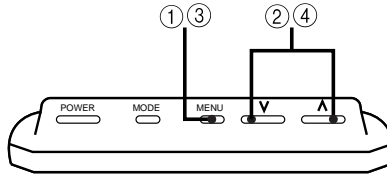

Example: Adjusting the black level

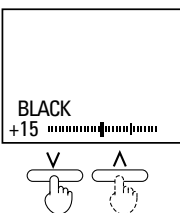
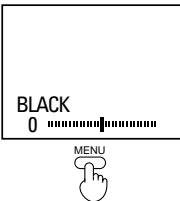
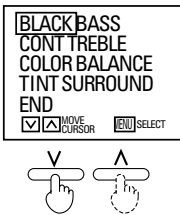
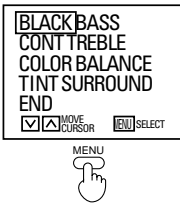

① Press the MENU button for 2 seconds or longer.

Note

- When END is selected, the system returns to the initial screen.
- For an RGB screen, only the Black level and Contrast are shown. (Not used at present.)
- If no operations are performed for a period of 30 seconds after pressing the MENU button
The Menu configuration screen automatically disappears.

② Select BLACK.

③ Press the MENU button.

④ Adjust the Black level.

Note

- After 10 seconds passes
The Black Level adjustment screen automatically disappears.

Adjustment points (Image features can be adjusted from the various setting screens)

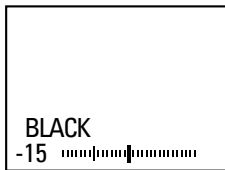

BLACK LEVEL

Makes the black portions of the screen easier to see (Night scenes, black hair, etc.)

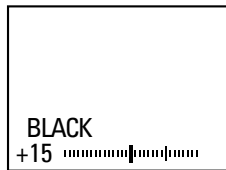

Adjust the Black Level when there is an inversion of the black and white on the screen or the screen appears too white due to an imbalance in the relationship between the installation position of the monitor and eye level.

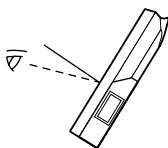

When the Black Level is on the negative [-] side.



When the Black Level is on the positive [+] side.

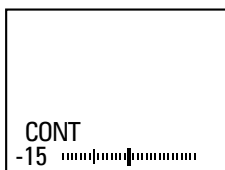

CONTRAST

Normally set in the middle. Move to the right for more contrast.

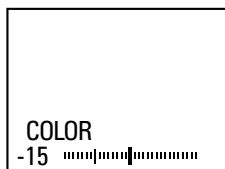
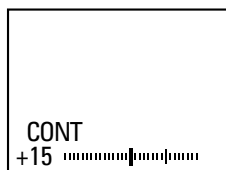

COLOR

Setting to slightly thicker colors

Colors are less vivid.

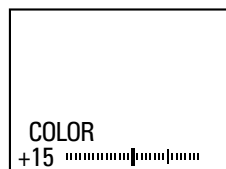

Colors are more vivid.



TINT

Setting for attractive skin color

Skin color has a red-dish-purplish tint.

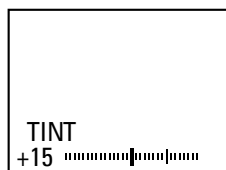

Skin color has a greenish tint.

Connecting to External Devices

Connection example 1

Mobile video machine or video camera (AV input 1) and car stereo (Audio output)

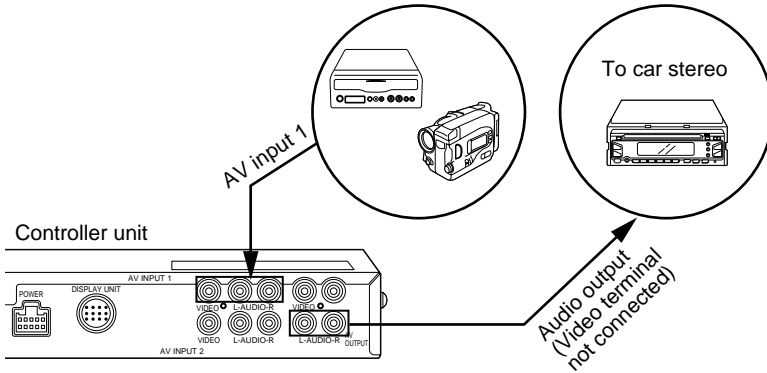

Connection example 2

Mobile video machine (AV input 1) and 2nd monitor (AV output)

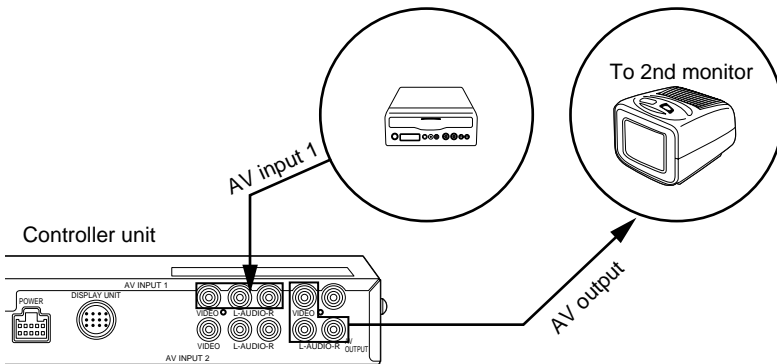



Note

- Refer to the installation manual for an explanation of how to make these connections.
- Since the connection cord varies depending on what external devices are connected, refer to the video equipment manual as well.
- For connection of a mobile video machine or video camera:
 - When howling (a "pi" sound) occurs, take one of the following steps.
 - Lower the volume on the monitor system
 - Use earphones (when the camera has an earphone jack)
 - Keep the monitor system and the camera microphone apart.

Troubleshooting

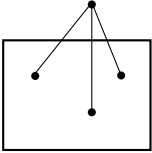
Please check the following items one more time.

When this occurs	Check these points	Reference page
<p>There are red, blue and green spots on the screen.</p> 	<p>This is a characteristic of liquid crystal panels and is not a problem.</p> <p>(The liquid crystal panel is built with very high precision technology and has at least 99.99% effective image pixels. Be aware that on 0.01% of the panel there may be missing pixels or constantly light pixels.)</p> 	<p>–</p>
<p>There is sound output, but no video output (only the channel number is shown).</p>	<ul style="list-style-type: none"> • Is the parking brake connection wire (gray color) connected? • The KV-M65 does not have a built-in TV tuner so no image is shown when it is set to the TV mode. • Was the parking brake lever pulled? 	<p>Refer to the installation manual</p>
<p>There is no sound from the speakers.</p>	<p>[Speaker Volume Adjustment] Is the volume on the lowest level?</p> <p>[Speaker Output Setting] Is the setting on No Output?</p>	<p>9 to 11</p> <p>9 to 11</p>
<p>The screen is dark. The screen black and white portions are inverted. The screen is too white.</p>	<p>[Brightness, Black Level and Contrast] Are the settings properly adjusted?</p>	<p>12 to 15</p> <p>18, 19</p>
<p>The color is thin. The tint is off.</p>	<p>[Color and Tint] Are the settings properly adjusted?</p>	<p>18, 19</p>

Maintenance

To prevent damage to the system exterior

Do not apply pesticides, benzene, thinner or other volatile substances to the unit.

The cabinet surface primarily consists of plastic materials.

Do not wipe with benzene, thinner or similar substances because this will result in discoloration or removal of the paint.

When a cloth with a cleansing chemical is used, follow the caution points.

Do not leave the unit in contact with rubber or vinyl products for long periods of time.

Do not use cleansers which have polishing granules because this could damage the surface of the unit.

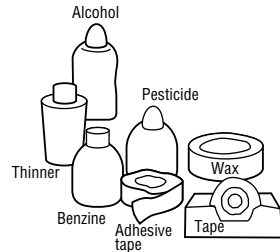

Clean dirt by wiping lightly with a soft cloth

When the unit is very dirty, wipe with a well-wrung cloth dipped in a kitchen cleanser (neutral) thinned by water and then go over the same surface with a dry cloth.

(Since there is the possibility of water drops getting inside of the unit, do not directly apply cleanser to the surface.)

① Wring well



Kitchen cleanser thinned by water

Wipe lightly



② Go over the same surface with a dry cloth



Request

If water drops or similar wet substances get inside of the monitor via the liquid crystal panel surface, it may cause a malfunction.

Specifications

Overall system	Product type	Mobile color monitor system
	Power source voltage	DC 14.4V (can be used within the range of 11V to 16V); negative ground only
	Usage temperature range	0°C to +40°C (32°F to 104°F)
	Storage temperature range	-20°C to +80°C (-4°F to +176°F)
Display unit	Liquid crystal panel	6-1/2"
	Screen dimensions	Width 13.3 cm (5-1/4"), height 10.0 cm (3-15/16"), diagonal 16.6 cm (6-9/16")
	Number of pixels	224,640 pixels (234 vertical x 320 horizontal x 3)
	Display method	Transparent color filter format
	Drive method	TFT (thin film transistor) active matrix format
	Visibility angle	Left/right: ±45°, Upward: 40°, Downward: 20°
	Light source	Internal light (W-shaped, cold cathode fluorescent light)
	Sound output	1 W
	Speaker	4 cm (1-5/8") round speaker (one)
	Dimensions	Width 18.8 cm (7-7/16"), height 12.8 cm (5-1/16"), thickness 3.5 cm (1-7/16")
Mass	600 g (1.4 lbs)	
Controller unit	Connection terminals	<ul style="list-style-type: none"> • Power, ground, parking brake, remote output connection terminals (10 pin connector) • Display unit connection terminal (13-pin DIN connector) • AV input 1 and input 2 terminals <ul style="list-style-type: none"> Video 1Vp-p(75Ω/RCA pin) Audio 0.5Vrms (RCA pin) • AV output terminal <ul style="list-style-type: none"> Video 1Vp-p(75Ω/RCA pin) Audio 0 to 0.5Vrms(RCA pin) (consecutive change supported by sound level adjustment)
	Dimensions	Width 19.6 cm (7-3/4"), depth 14.2 cm (5-5/8"), height 3.8 cm (1-1/2")
	Mass	800 g (1.8 lbs)

JVC

VICTOR COMPANY OF JAPAN, LIMITED